

2/2-way coaxial valve

Type 280 / 281 / 282

externally controlled

function A:

NC (normally closed)

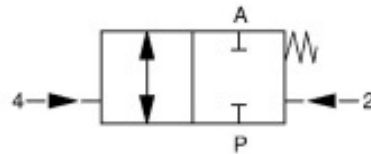

function B:

NO (normally open)

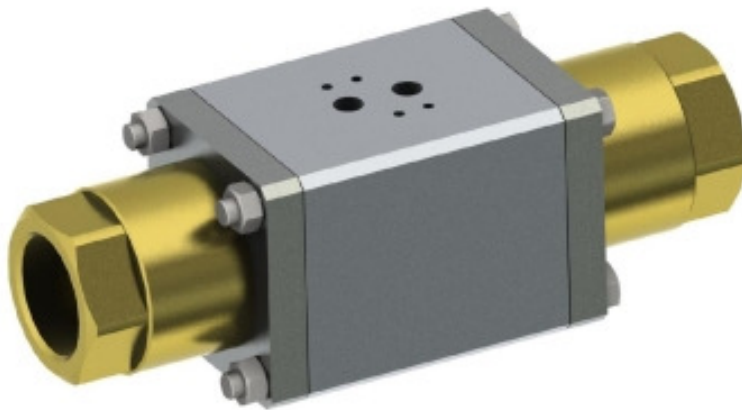
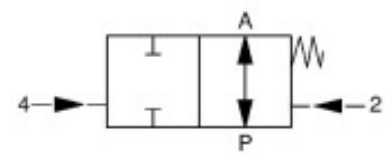

diameter	DN 10 – 50
pressure range	0 – max. 160bar backpressure leakproof up to max. 16bar
body material	threaded version: brass, AISI 303, AISI 316 flange version: steel galvanized steel nickel-plated, AISI 316
seal material	static: FKM dynamic: FKM, PTFE seat seal: PTFE
temperature	media: -10 up to +100 °C ambient: -10 up to +50 °C
connection	G1/4 – G2 flange see table page 4
flow direction	P → A max. 160bar A → P max. 16bar
actuating part	double acting piston with return spring
control pressure	3 – 8bar connections 2+4 (G1/4) port according to NAMUR an upstreamed service unit extends the lifetime of the valves
switching time	opening / closing 50 – 1000ms depending on operating pressure, pilot valve (option) and exhaust air throttle (option)
mounting	in any position

2/2-way coaxial valve

Type 280 / 281 / 282

type	DN [mm]	pressure range [bar]	connection	flow rate [m ³ /h]	weight – brass [kg]
280	10	0 – 64	G1/4, G3/8, G1/2	2,7	1,6
280	15	0 – 64	G3/8, G1/2, G3/4	7,2	2,8
280	20	0 – 64	G1/2, G3/4, G1	9,4	4,0
280	25	0 – 64	G3/4, G1, G1 1/4	14,5	5,3
280	32	0 – 64	G1, G1 1/4, G1 1/2	20,0	6,9
280	40	0 – 64	G1 1/2	45,7	11,7
280	50	0 – 64	G2	47,2	11,7
281	10	0 – 120	G1/4, G3/8, G1/2	2,7	1,6
281	15	0 – 120	G3/8, G1/2, G3/4	7,2	2,8
281	20	0 – 120	G1/2, G3/4, G1	9,4	4,0
281	25	0 – 120	G3/4, G1, G1 1/4	14,5	5,3
281	32	0 – 100	G1, G1 1/4, G1 1/2	20,0	6,9
281*	40	0 – 100	G1 1/2	45,7	11,7
281*	50	0 – 100	G2	47,2	11,7
282	10	0 – 160	G1/4, G3/8, G1/2	2,7	1,6
282	15	0 – 160	G3/8, G1/2, G3/4	7,2	2,8
282	20	0 – 160	G1/2, G3/4, G1	9,4	4,0
282	25	0 – 160	G3/4, G1, G1 1/4	14,5	5,3

* Auf Anfrage

sectional drawing

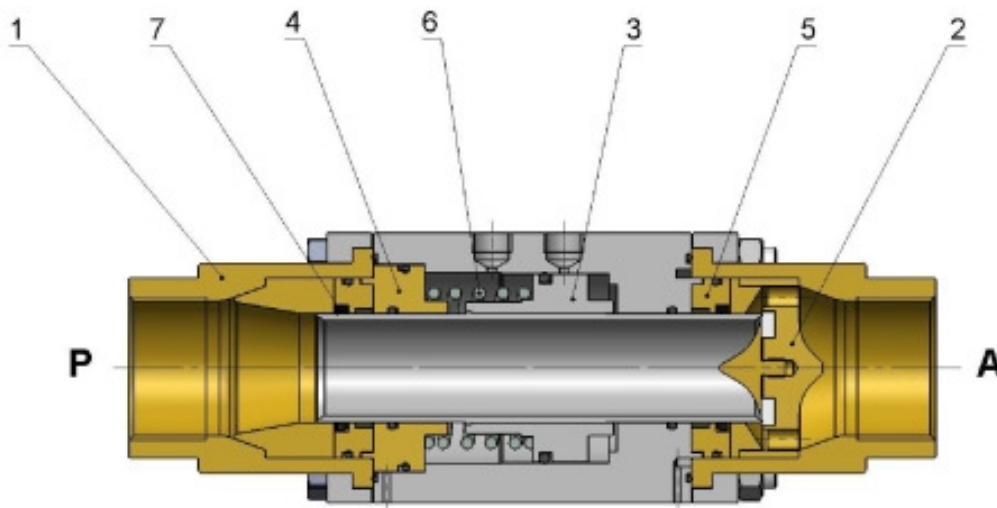

pos.	quantity	description
1	2	adapter fitting
2	1	valve seat
3	1	piston / control tube
4	1	actuating plate
5	2	guiding disk
6	1	spring
7	2	PTFE-rod seal

Coaxial-Valves.com

2/2-way coaxial valve

Type 280 / 281 / 282

dimension drawing

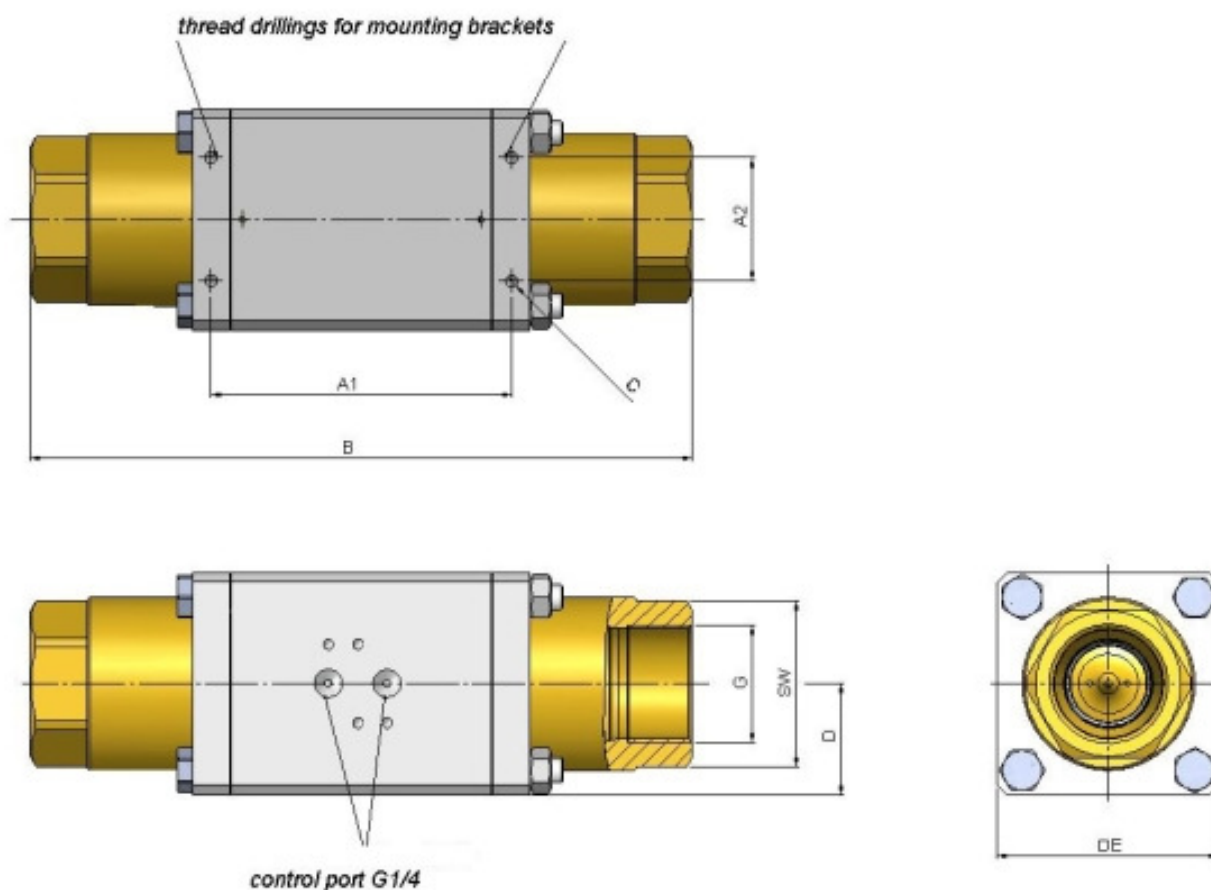

mounting face according to Namur

DN [mm]	G	SW	A1 [mm]	A2 [mm]	B [mm]	C	D [mm]	E [mm]
10	1/4, 3/8, 1/2	32	84	-	159,5	M4	25	50
15	3/8, 1/2, 3/4	41	100	-	184	M5	35	70
20	1/2, 3/4, 1	46	108	-	215	M5	40	80
25	3/4, 1, 1 1/4	55	121	-	246	M5	45	90
32	1, 1 1/4, 1 1/2	60	122	50	269	M6	45	90
40	1 1/2	75	131	60	304	M6	55	110
50	2	75	131	60	304	M6	55	110

Coaxial-Valves.com

2/2-way coaxial valve

Type 280 / 281 / 282

dimension drawing flange valves

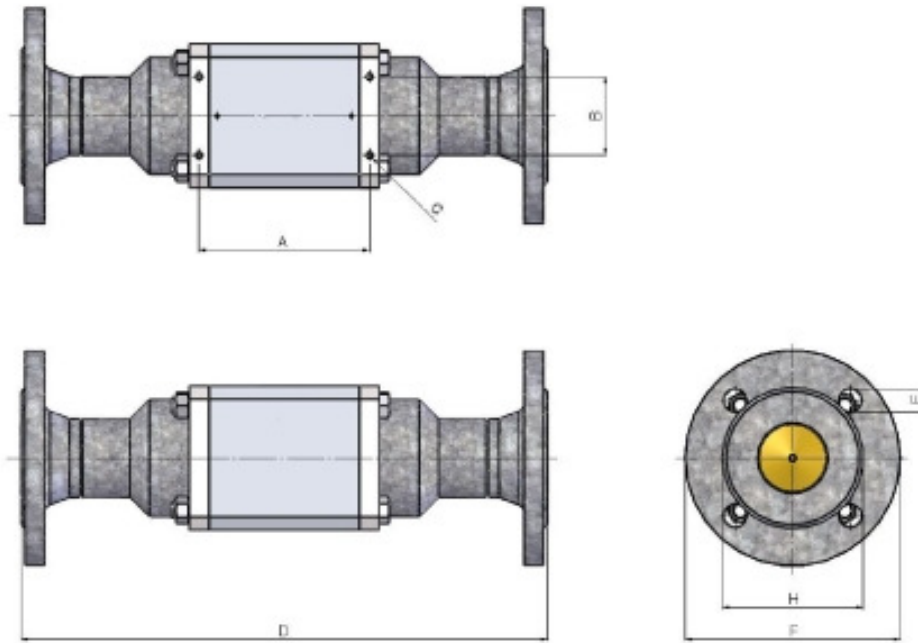

flange - standard		pressure rating	DN flange	DN valve	flow rate	A	B	C	D	E	F	H
DIN	EN	[bar]			[m ³ /h]	[mm]	[mm]	[mm]	[mm]	[mm]	[mm]	[mm]
2633	-	16	15	15	6,6	100	-	M5	242	14	95	65
2633	-	16	20	20	9,4	108	-	M5	269	14	105	75
2633	-	16	25	25	14,5	121	-	M5	302	14	115	85
2633	-	16	32	32	20,0	122	50	M6	324	18	140	100
2633	-	16	40	40	38,2	131	60	M6	385	18	150	110
2633	1092-1 Typ 11	16	50	50	47,2	131	60	M6	385	18	165	125
2635	1092-1 Typ 11	40	15	15	6,6	100	-	M5	242	14	95	65
2635	1092-1 Typ 11	40	20	20	9,4	108	-	M5	269	14	105	75
2635	1092-1 Typ 11	40	25	25	14,5	121	-	M5	302	14	115	85
2635	1092-1 Typ 11	40	32	32	20,0	122	50	M6	324	18	140	100
2635	1092-1 Typ 11	40	40	40	38,2	131	60	M6	385	18	150	110
2635	1092-1 Typ 11	40	50	50	47,2	131	60	M6	385	18	165	125
-	1092-1 Typ 11	63	50	50	47,2	131	60	M6	385	22	180	135
2636	-	64	50	50	47,2	131	60	M6	385	22	180	135
2637	1092-1 Typ 11	100	15	15	6,6	100	-	M5	242	14	105	75
-	1092-1 Typ 11	100	20	20	9,4	108	-	M5	269	18	130	90
2637	1092-1 Typ 11	100	25	25	14,5	121	-	M5	302	18	140	100
-	1092-1 Typ 11	100	32	32	20,0	122	50	M6	324	22	155	110
2637	1092-1 Typ 11	100	40	40	38,2	131	60	M6	385	22	170	125
2637	1092-1 Typ 11	100	50	50	47,2	131	60	M6	385	26	195	145
2638	1092-1 Typ 11	160	15	15	6,6	100	-	M5	242	14	105	75
2638	1092-1 Typ 11	160	25	25	14,5	121	-	M5	302	18	140	100

Coaxial-Valves.com

2/2-way coaxial valve

Type 280 / 281 / 282

type code

structure of the order specification:

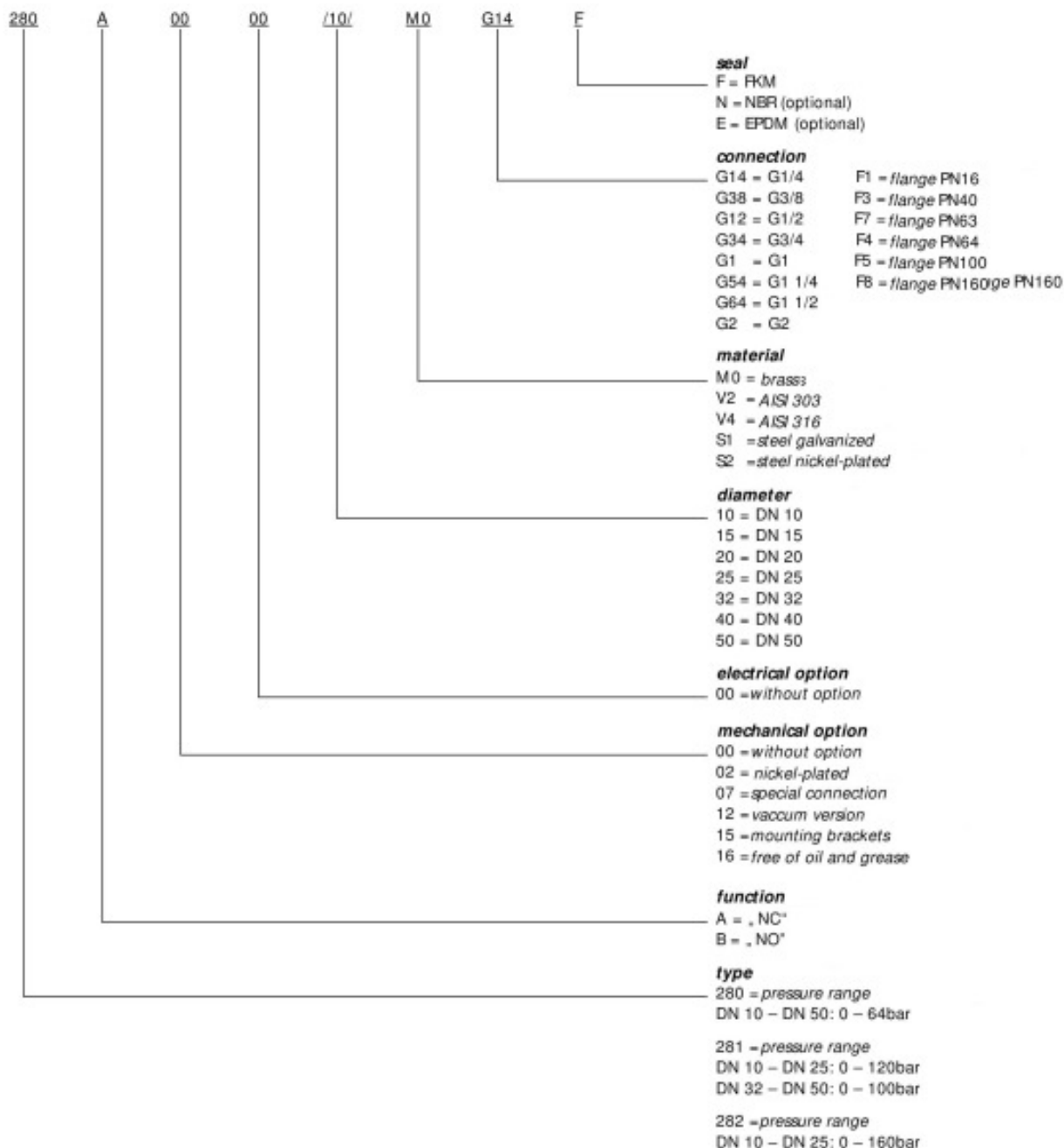



Coaxial-Valves.com

2/2-way coaxial valve

Type 280 / 281 / 282

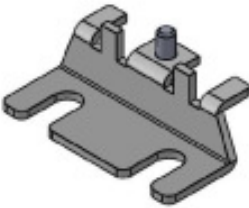
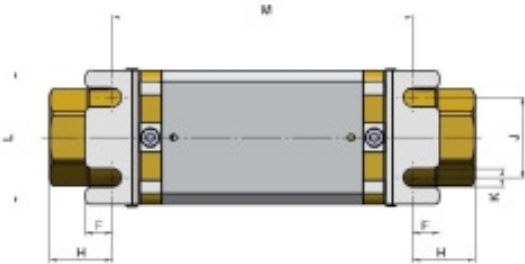

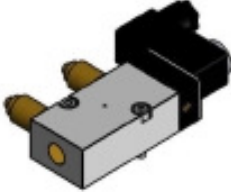



accessories

	<p>mounting brackets</p> <p>mechanical option = 15</p>	 <table border="1" data-bbox="826 768 1433 1066"> <thead> <tr> <th>DN</th> <th>F</th> <th>H</th> <th>J</th> <th>K</th> <th>L</th> <th>M</th> </tr> <tr> <th>[mm]</th> <th>[mm]</th> <th>[mm]</th> <th>[mm]</th> <th>[mm]</th> <th>[mm]</th> <th>[mm]</th> </tr> </thead> <tbody> <tr> <td>10</td> <td>10</td> <td>23,5</td> <td>30</td> <td>7</td> <td>50</td> <td>113</td> </tr> <tr> <td>15</td> <td>10,5</td> <td>22,5</td> <td>45</td> <td>7</td> <td>70</td> <td>139</td> </tr> <tr> <td>20</td> <td>15,3</td> <td>33,5</td> <td>50</td> <td>7</td> <td>80</td> <td>149</td> </tr> <tr> <td>25</td> <td>16</td> <td>34</td> <td>60</td> <td>8,5</td> <td>90</td> <td>178</td> </tr> <tr> <td>32</td> <td>6</td> <td>37</td> <td>78</td> <td>6,5</td> <td>90</td> <td>195</td> </tr> <tr> <td>40</td> <td>6</td> <td>40</td> <td>98</td> <td>6,5</td> <td>110</td> <td>224</td> </tr> <tr> <td>50</td> <td>6</td> <td>40</td> <td>98</td> <td>6,5</td> <td>110</td> <td>224</td> </tr> </tbody> </table>	DN	F	H	J	K	L	M	[mm]	[mm]	[mm]	[mm]	[mm]	[mm]	[mm]	10	10	23,5	30	7	50	113	15	10,5	22,5	45	7	70	139	20	15,3	33,5	50	7	80	149	25	16	34	60	8,5	90	178	32	6	37	78	6,5	90	195	40	6	40	98	6,5	110	224	50	6	40	98	6,5	110	224
DN	F	H	J	K	L	M																																																											
[mm]	[mm]	[mm]	[mm]	[mm]	[mm]	[mm]																																																											
10	10	23,5	30	7	50	113																																																											
15	10,5	22,5	45	7	70	139																																																											
20	15,3	33,5	50	7	80	149																																																											
25	16	34	60	8,5	90	178																																																											
32	6	37	78	6,5	90	195																																																											
40	6	40	98	6,5	110	224																																																											
50	6	40	98	6,5	110	224																																																											
	<p>exhaust air throttle</p> <p>G1/8</p> <p>G1/4</p>																																																																
	<p>silencer of sinter bronze casting</p> <p>G1/8</p> <p>G1/4</p>																																																																
	<p>5/2-way pilot valve (NAMUR) to flange connections laterally</p> <p>24V DC</p> <p>230V 50Hz</p>																																																																

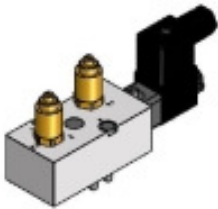
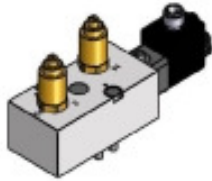
Coaxial-Valves.com

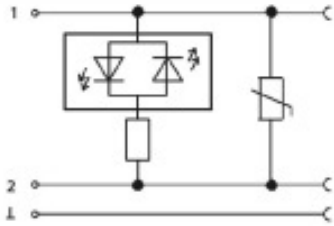
2/2-way coaxial valve



Type 280 / 281 / 282

	<p>5/2-way pilot valve (NAMUR) to flange connections above</p> <p>24V DC 230V 50Hz</p>	
	<p>(NAMUR)</p> <p>5/2-way pilot valve (NAMUR) to flange connections above solenoid M12 x 1</p> <p>24V DC 230V 50Hz</p>	
	<p>plug with LED</p> <p>electrical option = 20</p>	
	<p>24V DC</p> <p>plug with power reduction form A</p> <p>electrical option = 07</p>	
	<p>explosion proof</p> <p>II 2G Ex m II T4 II 3D IP65 T130°C</p> <p>electrical option = 13</p>	<p>operating pressure is reduced by 20% in Ex specification</p>

Coaxial-Valves.com

2/2-way coaxial valve

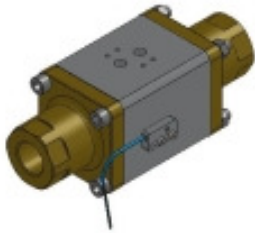
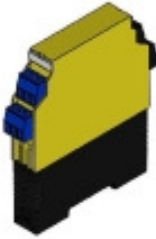
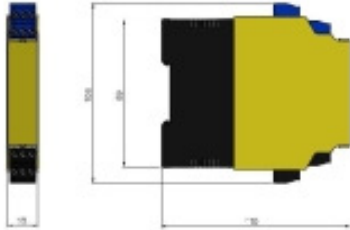
Type 280 / 281 / 282

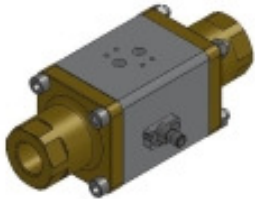
	<p><i>magnetic field sensor EX</i></p> <p>KEMA 04 ATEX 1152 X Ex II 1G Ex ia IIC T6 Ex II 1D Ex ia IIIC T95°C</p> <p><i>electrical option = 25</i></p>	
	<p><i>isolating switching amplifier 2-channel</i></p> <p>ATEX: II (1) G, II (1) D; II 3 G</p> <p><i>electrical option = ?</i></p>	
	<p><i>magnetic field sensor M12x1</i></p> <p><i>electrical option = 19</i></p>	

We gladly coordinate further options and accessories according to your requirements.